



Operating Instructions

Hydro Water Baths

H 4, H 8, H 16, H 22, H 24, H 41, H 8 A, H 16 A



The device series of Lauda Hydro Water Baths comprises eight models with six different sizes, ranging from 4 to 41 litres contents. Water Baths H 8 A and H 16 A are equipped with a circulation system, ensuring an optimum spatial temperature distribution.

The outer housing is made of electrolytically galvanised and powder-coated sheet steel; all other constructive parts of the housing and the heating element are made of stainless steel.

Three timer functions of the electronic controller permit regulation of the water temperature in the Water Bath. The controller is equipped with an electronic performance check with visual and acoustic alarms in case of a malfunction. Furthermore, the Water Baths are protected in case of dry running of the heating element.



Before installation, please check whether contents of package are in good order and complete.

Should you note any damages or have any reasons for complaint, please contact your supplier or directly.

LAUDA DR. R. WOBSE R GMBH & CO. KG

Schulze-Delitzsch-Str. 4+5

30938 Burgwedel - Germany

Telefon: +49 (0)5139 9958 0

Fax: +49 (0)5139 9958 21

E-Mail: info@lauda.de

Internet: <https://www.lauda.de>

Translation of the original operating instructions

Q4DT-E_13-005-EN-01, 03.07.2023

© 2023 LAUDA DR. R. WOBSE R GMBH & CO. KG

Contents

1	Use of the Water Bath	7
1.1	Intended Use.....	7
1.2	Improper Use	7
2	Warranty conditions	7
3	Before Installation / Initiation	8
4	Transport, Setup and Location of the Water Baths	8
5	Operating Voltage	9
6	Filling water into the Water Bath	9
7	Adjustable Water Level Regulator (Accessory Order-No. A000024)	10
8	Functional Description and Initiation	10
8.1	Main Menu	11
8.1.1	<i>Setting the required temperature</i>	12
8.1.2	<i>Setting the switch-on delay</i>	12
8.1.3	<i>Setting the operation time of Water Bath heating</i>	13
	Switching to menu basic settings	13
8.2.1	<i>Limitation of the max. or min. possible temperature set points in two separate input windows</i>	15
8.2.2	<i>Setting the trigger points for over- and under-temperature alarms in two separate input windows</i>	15
8.2.3	<i>Switching between temperature display °C and °F</i>	16
8.2.4	<i>Start options of the process duration</i>	17
8.2.5	<i>Adjusting the actual temperature at a certain set point temperature</i>	17
8.2.6	<i>Switching back to the main menu</i>	18
8.3	Display of current process data	18
8.4	Function control with visual and acoustic alarms	19
9	Water Circulation (Only Water Baths models H 8 A und Typ H 16 A)	20
10	Maintenance and Support	20
10.1	Exchanging the internal unit fuses	20
10.2	Low water cut-off.....	21
10.3	Under-temperature alarm	21
10.4	Over-temperature alarm	22
10.5	Temperature sensor is interrupted	22
10.6	Temperature sensor has short circuit.....	22
10.7	Removing Lime Deposits, Cleaning and Maintenance.....	23
10.7.1	<i>Descaling</i>	23
10.7.2	<i>Cleaning and Maintenance</i>	23
10.7.3	<i>Decontamination</i>	23

10.8	Technical support.....	23
11	Disposal of Old Units	24
12	Technical Data.....	25
13	Circuit diagram.....	26
14	Examples for connection to the mains supply.....	27
14.1	Electrical fuses.....	27
14.2	Examples for connection to the mains	28
15	Accessories.....	29
16	Notes.....	30
17	Ordering spare parts / LAUDA Service.....	31
18	Product Returns and Clearance Declaration	32
19	EC Declaration of Conformity and certificates.....	33

1 Use of the Water Bath

1.1 Intended Use



LAUDA Hydro Water Baths are used to heat up tap water in a temperature range of approx. 5 K above ambient to 100 °C (models H 4 to H 41) and from approx. 10 K above ambient to 100 °C (models H 8 A and H 16 A) for temperature-controlled warming of different media in laboratory vessels of different shapes.

The information contained in these operating instructions must by all means be read and observed. Only then can a perfect operation of the Water Bath be guaranteed. The units may only be installed and operated by persons who have made themselves familiar with these operating instructions.



Caution:

Hot surfaces at temperatures above 50 °C. Danger of burns, and danger of scaldings through steam released when opening the lid of the Water Bath. It is recommended to wear suitable safety gloves.



Caution:

Increased risk of injury! Uncontrolled closing of the Water Bath lid carries a high risk of injury. Protect yourself by working carefully on Water Baths with open lid.

1.2 Improper Use

Use the LAUDA Hydro Water Bath with tap water only. Other media, e. g. oils or acids, will lead to damages and, possibly, total unit failure. Neither aggressive nor corrosive waters may be used as a thermostating liquid.

The Water Bath may not be used in laboratory areas with aggressive or corrosive ambient conditions. It is not permissible to heat up or vaporise aggressive media, e. g. hydrochloric acid, in the unit itself or in its vicinity.

The temperature work must not create an explosive atmosphere in the vicinity of the unit.

The Water Bath may not be operated in potentially explosive surroundings.

LAUDA Hydro Water Baths are not suitable for direct temperature work of foodstuffs, beverages and tobacco or for medical-technical and pharmaceutical products. Direct temperature work means unprotected contact of the substances with the Water Bath filling.

LAUDA Hydro Water Baths, operated in a laboratory, are no Medical Devices. They neither fall under national nor international Medical Device Directives nor have to be used and applied accordingly.

2 Warranty conditions

LAUDA offers a standard 12 month manufacturer's warranty from the date of purchase.

3 Before Installation / Initiation

The information given in the present manual must by all means be carefully read and observed. Only then can a perfect functioning of the Shaking Water Bath be guaranteed.

Safety precautions are additionally marked with the following symbols.



Read and observe the operating instructions



Warning of hot liquids and vapour



Warning of hot surfaces



Warning of hand injuries



Warning of dangerous electrical voltage



General warning

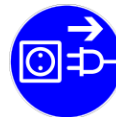

Before maintenance and repair disconnect the unit all-pole from the electrical mains (pull the plug from the socket).

4 Transport, Setup and Location of the Water Baths



Protect yourself and the unit during transport and setup by working carefully and avoid danger of e. g. shifting or tilting the unit as well as risk of injury by lifting heavy loads.

Caution, Water Bath Typ H 41 has a net weight of 21.2 kg and must be lifted, carried and transported to the location by at least two persons.

The Water Bath can be held between the four stands of the unit and lifted for setup. Place on solid, even and level surfaces inside buildings only. Make sure to place the unit only on a watertight, temperature-resistant, non-flammable surface. The location must provide sufficient space as well as the necessary carrying capacity for the unit (unit weight as per technical data, chapter 12 of this manual plus weight of the filling).

5 Operating Voltage



The Water Bath must be connected to a correctly installed shock-proof socket. The Water Bath is a protection class I electrical appliance, a connection to the earth conductor (PE) must be ensured. For information on the required mains fuse please view Technical Data, chapter 12 of this manual. Further reference for connection to the mains can be found in chapter 14 of this manual.



The electrical connection must ensure an all-pole separation from the mains at any time. The mains connection cable must not touch any hot surfaces of the unit. It may not lead underneath the unit. The main switch of the Water Bath must be off (position ○). The voltage on the nameplate (at the back of the unit) must be identical to the mains voltage. If they are identical, connect the unit to the mains.

6 Filling water into the Water Bath



Use the Water Bath only with tap water. Even stainless steel will corrode when used improperly. Use neither ferruginous nor chlorous water, in order to prevent rust formation and pitting. Using distilled or deionised water will also ultimately lead to corrosion in the Water Bath and must, therefore, be avoided.

Media, such as oil, acid, or other additives, not approved by LAUDA, to prevent bacteria contamination (chlorine or copper sulphate), may lead to damages to the Water Bath basin, the screw connections of the ducts and the heating element. Such damages are not covered by guarantee.

Before initiation, the Water Bath must be filled with water. For maximum filling quantities please refer to the Technical Data, chapter 12 of this manual. Make sure that the drain cock at the back of the unit is locked (handle must be in a 90° angle to the drain cock). Open the lid of the unit and fill in water at least up to the marking "min" (approx. 50 mm above the perforated floor) and not exceeding the marking "max" (approx. 50 mm below the upper bath rim).

7 Adjustable Water Level Regulator (Accessory Order-No. A000024)

The adjustable water regulator at the back of the Water Bath serves to level out the loss of water due to evaporation during operation, thus maintaining the set water level. Furthermore, the adjustable water regulator allows the Water Bath to be operated at temperatures below ambient, with a minimum of approx. 3 K above tap water temperature.

Before initiation, the water regulator must be connected to the water mains. The upper hose connection of the water regulator is the water supply. Using a laboratory hose with an inner diameter of max 9 mm, connect this to the water mains. The lower hose connection is the overflow of the water regulator. Connect a laboratory hose (inner diameter of max 9 mm) and lead it into a drain on a lower level, ensuring free flow of the water without it being banked up.

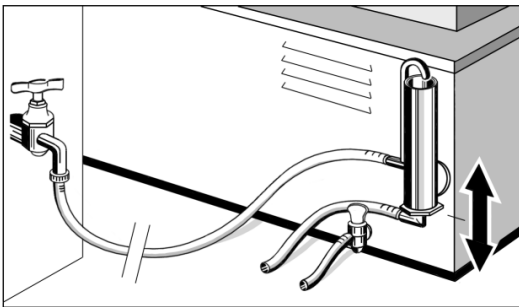

Secure all hose connections with hose clips.

The required water level can be adjusted with the outlet tube of the water regulator. First loosen the screw connection of the outlet tube, using a spanner GW 27. Set the required water level by pulling out or pushing in the tube in the regulator. Then retighten the screw connection. Now open the tap of the mains supply slightly and fill water into the Water Bath, as described in chapter 6.

8 Functional Description and Initiation



The electronic regulator controls the water temperature of the Water Bath. Three timer functions permit switch-on delay as well as setting the duration of the operation time. A high-contrast 3.5" TFT display shows all set points and operational values. These can be controlled with four membrane keys, situated to the right of the display. The controller is equipped with an electronic monitoring function with visual and acoustic alarms in case of a malfunction. Additionally, the Water Bath is protected from overheating through running dry by a low water cut-off that is also monitored by the function control of the regulator. After switching on the main switch of the Water Bath, the green pilot lamp in the switch will light up. The display first shows the startup screen, and then the main menu. The four membrane keys to the right of the display allow access to all menu functions, setting and confirming process values.

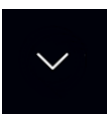

Key ① to reduce process values and to switch between menu functions.

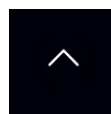

Key ② to increase process values and to switch between menu functions.

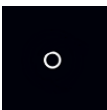

Key ③ to open and close input windows, confirm set process values and to leave sub-menus.



Key ④ to start and stop processes.

8.1 Main Menu

The Water Bath is started in the main menu after checking the set points. Sub-functions of the main menu permit setting and saving the values for temperature, switch-on delay and operation time. The current set points are shown below the symbols of the relative function and remain saved after switching the Water Bath off. Furthermore, the main menu permits access to the basic settings of the regulator. The bottom line of the following input windows provide information on the tasks assigned to keys ①, ② and ③.



Keys ① and ② permit to move in the menu. The current function is marked in gray and can be opened with key ③. If the saved set points below the function symbols are in conformity with your process requirements, the Water Bath can be started by pressing key ④ (keep pressed for 3 seconds) and switched off again by pressing key ④ (shortly).

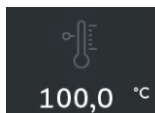

Set temperature with currently saved set point (see 8.1.1)



Switch-on delay with currently saved set point (see 8.1.2)



Operation time with currently saved set point and pre-set timer functions (see 8.1.3)



Basic settings (see 8.2)

8.1.1 Setting the required temperature

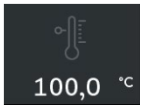

In this input window, the required temperature of a process is set. The temperature can be set between 10 °C and 100 °C. The setting range of the required temperature can be limited within the values pre-set in the basic setting menu (see 8.2.1) and is displayed in either °C or °F (see 8.2.3). Set point 100 °C is a pure boiling mode. The Water Bath's heating element is supplied with energy constantly.

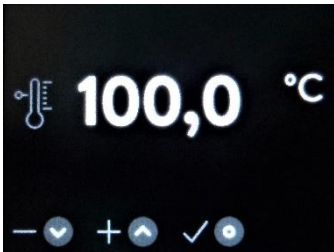

Use keys ① and ② to set the required temperature value, confirm with key ③ and return to the main menu. The set point is now displayed beneath the temperature symbol in the main menu.



Key ①



Key ②



Key ③

Factory setting 50.0 °C

8.1.2 Setting the switch-on delay

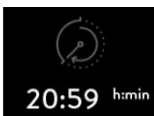

In the opened input window, the value t in hours and minutes (h:min) for delayed switch-on of the heating can be pre-set. The delay can be set between 0:00 (operation without delay) and max 999:59 h:min.

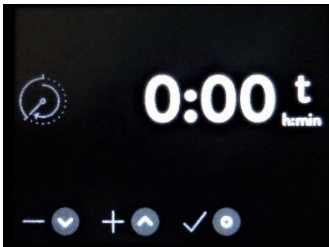

Set the required time value with keys ① and ②, then confirm with key ③ and return to the main menu. The set delay will be displayed beneath the symbol of the switch-on delay in the main menu.



Key ①



Key ②



Key ③

Factory setting 0:00 h:min

8.1.3 Setting the operation time of Water Bath heating



In this input window, the operation time t in hours and minutes (h:min) or continuous operation can be set. The operation time is to be set from ∞ (continuous operation) through 0:01 to max. 999:59 h:min. The pre-set starting option of the timer, set in the menu "basic settings" (see 8.2.4), is displayed symbolically beneath the function symbol for operation time.

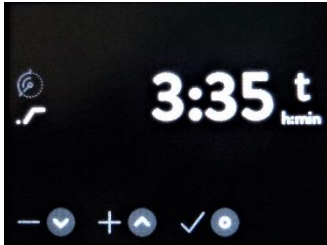

Start of operation time right after expiry of the delay.



Delayed start of operation time after expiry of the delay, approx. 0.1 K before reaching the set temperature.

Use keys ① and ② to move in the menu. The current function is marked in black, key ③ opens the input window to define the required pre-set value.



Key ①



Key ②



Key ③

Factory setting: Start of operation time right after expiry of delay, operation time ∞

8.2 Switching to menu basic settings



In the menu basic settings, pre-sets for temperature, over- and under-temperature alarms as well as operation time can be defined. Furthermore, the menu offers a temperature calibration.



Use keys ① and ② to move in the menu. The current function is marked in gray, key ③ opens the input window to define the required pre-set value.



Key ①



Key ②



Key ③



Limitation of maximum possible temperature that can be pre-set
(see 8.2.1)



Limitation of minimum possible temperature that can be pre-set
(see 8.2.1)



Setting trigger point of over-temperature alarm
(see 8.2.2)



Setting trigger point of under-temperature alarm
(see 8.2.2)



Switching between temperature display °C und °F
(see 8.2.3)



Switching between start options of the process duration
(see 8.2.4)



Adjusting the actual temperature
(see 8.2.5)



Switching back to main menu
(see 8.2.6)

8.2.1 Limitation of the max. or min. possible temperature set points in two separate input windows



The operating temperature of Water Baths models H 4 to H 41 is between approx. 5 K above ambient, from models H 8 A and H 16 A approx. 10 K above ambient, to 100 °C (boiling point). Both minimum and maximum temperature set points can be limited in two input windows.



The maximum set point can be defined between 10.1 °C and 100 °C, the minimum set point between 10.0 °C and 99.9 °C. The values of both functions are interlocked. The maximum limitation of the set temperature cannot be set lower than the minimum limitation and vice versa. Therefore, the temperature can be set and limited between 10 °C and 100 °C.

Use keys ① and ② to set the required temperatures, confirm with key ③ and return to the display of menu basic settings.



Key ①



Key ②



Key ③

Factory setting maximum possible temperature set point 100 °C

Factory setting minimum possible temperature set point 10.0 °C

8.2.2 Setting the trigger points for over- and under-temperature alarms in two separate input windows



After the set temperature of a current process has been reached for the first time, the alarm functions for over- and under-temperature are activated. If the actual temperature then exceeds or falls below the temperatures determined in the input windows, the current process is interrupted, and an acoustic and visual alarm is triggered.

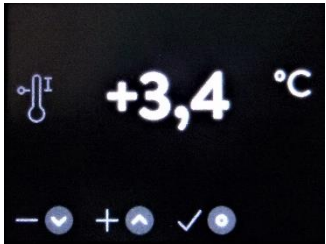

The switch-on point for the over-temperature alarm can be set between 0.0 K and +10 K above the set point temperature. The switch-on point for the under-temperature alarm can be set between 0.0 K and -10 K below the set point temperature. Only if process-related and absolutely unavoidable, should the value for the under-temperature alarm be set lower than -4.0 K and the over-temperature alarm to values lower than +2.0 K.

Use keys ① and ② to set the trigger points of the alarm functions, confirm with key ③ and return to the display of the menu basic settings.



Key ①



Key ②



Key ③

Factory setting over-temperature alarm +4.0 K

Factory setting under-temperature alarm -9.0 K

8.2.3 Switching between temperature display °C and °F



All temperature values in the display can either be displayed in °C or °F.

Use keys ① and ② to switch between °C and °F. The chosen temperature unit is marked in gray and can be confirmed with key ③. The display returns to the menu basic settings.

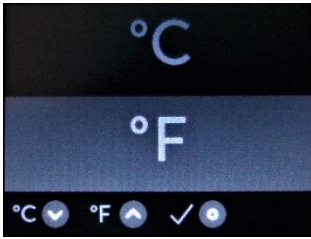

Key ①



Key ②



Key ③

Factory setting °C

8.2.4 Start options of the process duration



The set process duration starts either after expiry of the pre-set delay time (upper line), or after expiry of the delay time approx. 0.1 K before reaching the pre-set temperature.

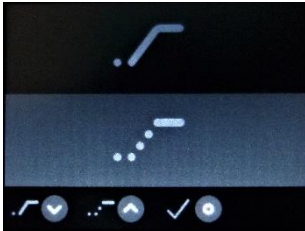

Use keys ① and ② to switch between the two start options. The chosen option is marked in gray and is confirmed with key ③. The display returns to the menu basic settings. The symbol of the selected start option is always shown together with the symbol of the operation time in the input and display windows.



Key ①



Key ②



Key ③

Factory setting start right after expiry of pre-set delay

8.2.5 Adjusting the actual temperature at a certain set point temperature



The user can adjust the actual temperature at a certain process-dependent set point temperature. To do this, compare the actual temperature shown on the display, after two hours operation with the Water Bath interior covered, with the displayed value of an external, calibrated thermometer in order to determine the temperature difference of the measured values. This difference must then be implemented in the input window of the adjusting function.



Example, after a process duration of two hours at a temperature of 50 °C

Temperature value in the display 50,0 °C

Value measured with external thermometer 49,2 °C

Difference to the externally measured temperature -0,8 K

In this case, the value in the input window of the adjusting function must be changed by -0.8 K from +3.4 K to +2.6 K in order to adjust both temperature values.

Set the altered temperature value with keys ① and ② and confirm with key ③. The display returns to the menu basic settings.

The changed value should be re-confirmed by a second, ensuing temperature measurement.



Key ①



Key ②



Key ③

A factory adjustment was carried out at a temperature of 50 °C.

8.2.6 Switching back to the main menu

Use key to switch back from the menu basic settings to the main menu.



8.3 Display of current process data



After starting the Water Bath with the pre-set process data, press key ④ (hold for 3 seconds) to open a display field showing the current process data: set and actual values of temperature in °C or °F, switch-on delay and operation time with their relative function symbols. Expiry of a pre-set process time is indicated by an acoustic signal which is to be confirmed with key ③ to be switched off. By pressing key ④ (shortly) all temperature processes are ultimately terminated, the display of the current process data switches off and returns to the main menu.



Key ③



Key ④



The upper line shows the actual temperature. The symbol shown to the left of the temperature value indicates whether the device is heating. The actual temperature in the example is 28.3 °C.



Display of the set temperature, in the example 100 °C

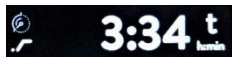

Remaining run times of delay and/or operation times (∞ when in continuous operation) with their relative function symbols. A flashing function symbol signals running-down times of process times, parallel to the reducing time value. In the example, the process will run for another 3:34 h:min and started without switch-on delay.

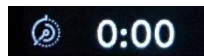

Pre-set set point of the delay time. The example shows 0:00 h:min, immediate start without switch-on delay.

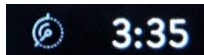

Pre-set set point of the operation time. In the example 3:35 h:min.

Caution,
observe by all means.

To switch off the unit for longer down-times first switch the main switch to position O, then disconnect the unit from the mains. The Water Bath must be emptied, and the interior dried in order to avoid germ contamination.

8.4 Function control with visual and acoustic alarms

The temperature controller is equipped with an electronic function control. The following features are supervised: the switching contact of the low water cut-off, the pre-set values for over- and under-temperature alarms (see chapter 8.2.2), and the temperature sensor B1 (see chapter 13) for short circuit and interruption. In case of a malfunction acoustic and visual alarms will be induced. Visually, the kind of malfunction will be coded on the display, alternating with the current operation data, pending the user's confirmation (ill. 1 and 2).



ill 1



ill 2

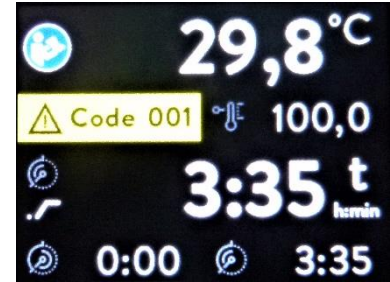

ill 3

The current process stops, heating as well as running time functions. After confirming the displayed malfunction with key ③, the acoustic alarm is switched off and the visual indication (ill. 1) of the kind of malfunction disappears. The malfunction, marked in yellow and with a "caution" symbol, as well as the code number remain shown in the display of on-going process data (see ill. 3). The blue symbol indicates the necessity of consulting the operating instructions. Error codes 001, 002 and 003 must be reset by pressing key ④ (shortly), error codes 004 and 005 must be reset by switching off the Water Bath's main switch. Only after a technical analysis of the malfunction should the terminated process be restarted.

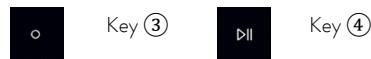

Error code displayed by the function control in case of a malfunction



Code 001 Low water cut-off has been triggered and must be reset.



Code 002 Under-temperature alarm after the actual temperature falling below the pre-set value (see chapter 8.2.2).



Code 003 Over-temperature alarm after the actual temperature exceeding the pre-set value (see chapter 8.2.2).



Code 004 Temperature sensor is interrupted.



Code 005 Temperature sensor has short circuit.

Caution For further information and support on maintenance of a Water Bath after an error report of the function control please view chapters 10.3 to 10.6 of these operating instructions.

9 Water Circulation (only Water Baths models H 8 A und Typ H 16 A)

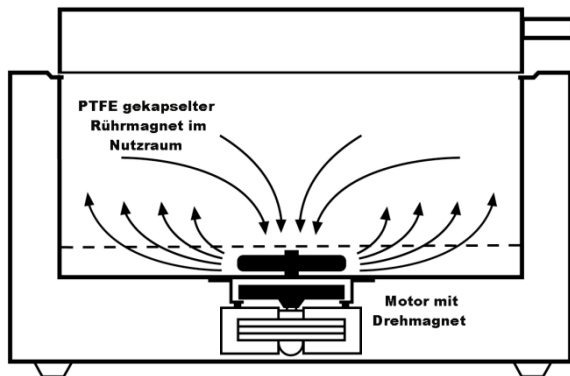

The circulation system ensures an optimized temperature distribution throughout the whole Water Bath. It is operated by an electric motor with stirring magnet, flanged to the Water Bath basin, that transmits its torque to a PTFE-coated stirrer. The stirrer draws the water to the middle of the basin and then moves it back to all sides. The electric motor of the water circulation is activated via the main switch.

10 Maintenance and Support



Caution! Prior to maintenance and cleaning let the Water Bath cool down!
If required, the water in the Water Bath can be drained through the drain cock at the back of the Water Bath.
Caution: Danger of burns!

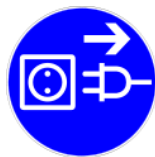

Make sure to prevent liquids coming into contact with cable connections or the inside of the electrical appliance. Except when descaling the unit (see chapter 10.7) disconnect the unit from the mains by pulling the plug, thus separating the Water Bath all-pole from the mains. Repairs of the electrical system may only be carried out by a trained electrician.

10.1 Exchanging the internal unit fuses

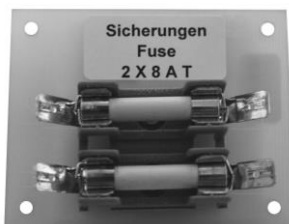

In direct proximity of the mains connection cable's screw joint, the mains fuses F1 and F2 (see chapter 13) are fixed on a fuse holder in the inside of the Water Bath. In order to check and to exchange the fuses, the bottom plate of the Water Bath must be removed. The fuses may only be exchanged against fuses of identical specifications. For information on the fuses used please view the label next to the fuses as well as the spare parts list (see chapter 15).



In addition to the following chapters 10.2 to 10.6 please observe by all means the information in these operating instructions, chapter 8.4, on resetting alarm reports of the function control.

10.2 Low water cut-off



Code001

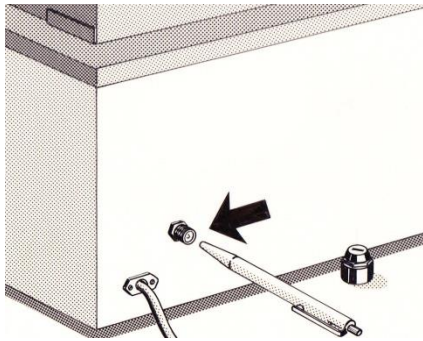

The heating element of the Water Bath is protected against destruction through running dry by a low water cut-off (thermostatic over-temperature limiter). In case of low water, the ongoing process is aborted and power supply to the heating element is cut off. The display of the temperature controller shows error code 001. Before restarting the unit, the Water Bath's tank must be filled with water, as described in chapter 6 filling water into the Water Bath, and the triggered low water cut-off must be reset.

To do so, loosen the black cap nut at the back of the Water Bath. Within the thread, a white plastic pin will now be visible which must be gently pushed inside (e. g. with a pen) until a soft clicking sound can be heard. Error code 001 could also be displayed alternating with the under-temperature alarm error code 002.

The efficiency of the low water cut-off can be checked by a temperature-controlled heat-up of the capillary tube sensor, e. g. with a hot air fan (after loosening the clamps from the heating element) exceeding the switch-off temperature of 135 °C. The contact position of the fuse can be checked by a resistance measurement, after pulling off the cables. If the fuse was triggered, the safety switch F3 (see chapter 13) will be open.

This examination must be carried out by a trained electrician.

10.3 Under-temperature alarm



Code002

If the actual temperature falls below the alarm set point, the current process is aborted. The display of the temperature controller shows error code 002. Check the set trigger point of the alarm (see chapter 8.2.2) and set it to -9.0 K. Restart and observe the process in order to determine a possibly visible cause for the drop of the actual temperature, for example

- heavy under- or overshooting of the temperature in the tank during the regulation process
- inserting samples into the water that are too cold
- this alarm might also be shown alternating with error code 001 in connection with the low water cut-off being triggered

10.4 Over-temperature alarm



Code003

If the actual temperature falls below the alarm set point, the current process is aborted. The display of the temperature controller shows error code 003. Check the set trigger point of the alarm (see chapter 8.2.2) and set it to $> +4.0$ K. Restart and observe the process in order to determine a possibly visible cause for the drop of the actual temperature, for example

- heavy under- or overshooting of the temperature in the tank during the regulation process.
- Please also observe the heating symbol (see chapter 8.3) that indicates the energy supply to the heating element. If the actual temperature is above the set point, it is blanked.
- inserting samples into the water that are too warm
- possible defect of controller A1 or the Triac V1 (see chapter 13)
- set point temperature too low in relation to the ambient temperature (see chapter 12)

10.5 Temperature sensor is interrupted



Code004

Temperature sensor B1 (see chapter 13) of the controller is constantly checked for interruptions. In case of a defect the current process is aborted. The display of the temperature controller shows error code 004.

The temperature sensor can be checked by a resistance reading after pulling off contacts X6 and X7 of the temperature controller A1 (see circuit diagram, chapter 13).

Typical resistance measurements of a non-defective temperature sensor are:

- at 20 °C ambient temperature between 1901 and 1944 Ohm
- at 25 °C ambient temperature between 1980 and 2020 Ohm

Furthermore, this error code might also indicate a defective controller A1.

10.6 Temperature sensor has short circuit



Code005

Temperature sensor B1 (see chapter 13) of the controller is constantly checked for short circuits. In case of a defect the current process is aborted. The display of the temperature controller shows error code 005.

The temperature sensor can be checked by a resistance reading after pulling off contacts X6 and X7 of the temperature controller A1 (see circuit diagram, chapter 13).

Typical resistance measurements of a non-defective temperature sensor are:

- at 20 °C ambient temperature between 1901 and 1944 Ohm
- at 25 °C ambient temperature between 1980 and 2020 Ohm

Furthermore, this error code might also indicate a defective controller A1.

10.7 Removing Lime Deposits, Cleaning and Maintenance



The perforated floor can be removed from the Water Bath for cleaning procedures.
Caution, danger of scaldings! Do not reach into the hot water in the tank.

10.7.1 Descaling

Lime deposits in the tank can be removed with commercial descaling agents (e. g. rea-calc® of M/s CHEMOTEC GmbH, 63486 Bruchköbel, Germany). Any descaling agent used must be admitted for use with stainless steel and must only be used according to the manufacturer's instructions. After descaling the boiler, rinse it several times with water in order to safely remove all remaining traces of the descaling agent.

Never use products containing hydrochloric acid. These will damage the heating elements, the temperature sensors as well the tank and the screw connections of the ducts.

10.7.2 Cleaning and Maintenance

The original shine of the stainless steel surfaces of the tank can be restored with commercial stainless steel polishing agents (e. g. "Helios Brillant" of M/s Ecolab Deutschland GmbH, 40789 Monheim, Germany). The powder-coated surfaces of the housing can be cleaned with mild, non-abrasive and pH neutral cleaning agents.

Never use cleaning agents with solvents!

It is advisable to exchange the water in the tank in regular intervals in order to prevent germ formation. The drain cock is situated at the back of the unit.

10.7.3 Decontamination

Should the Water Bath have been contaminated with dangerous substances, cleaning and decontamination measures must be carried out according to the safety data sheets of these substances. It may be necessary afterwards to have the unit tested for function and safety by a trained electrician or by the service department in the manufacturing plant.

For technical support concerning LAUDA Hydro Water Baths, please do not hesitate to contact our Service Department.

Please contact your dealer or us before returning a defective unit and do not return it before consulting us. A defective unit may only be returned thoroughly cleaned, decontaminated, if necessary, and carefully packed, accompanied by a detailed description of the defect

10.8 Technical support

You can call our customer service at any time for technical support relating to LAUDA Hydro Water Baths appliances.

Phone : +49 (0) 9343 / 503-350

Fax : +49 (0)9343 503-283

Email : service@lauda.de

Maintenance, repairs and modifications must be carried out by a qualified electrician (section 2 (3) DGUV Regulation 3) according to the General Rules of Technology (section 2 (2) DGUV Regulation 3). Only original spare parts may be used. Request that the person performing the work provides written confirmation of the type and scope of the work carried out (company, date, signature).

11 Disposal of Old Units

LAUDA will take responsibility, within the scope of the legal directives, for an environmentally sound handling and disposal of all used units as of the production year 1995 that are returned to us free of charge and will have it materially recycled. Before the unit is returned, a legally binding declaration must be provided from the sender confirming that the unit is free from harmful and/or hazardous contaminations as well as from hazardous substances caused by the previous use of the unit.

LAUDA laboratory apparatus are exclusively designed for industrial use and may not be disposed of through public waste disposal authorities. EAR Registration Number WEEE-ID.NO.DE 67770231

12 Technical Data

Dimensions	H 4	340 mm x 290 mm x 275 mm / 245 mm x 100mm x 165 mm
Model / Exterior dimensions (W x D x H in mm x mm x mm)	H 8	340 mm x 395 mm x 275 mm / 245 mm x 200 mm x 165 mm
/ Interior dimensions (W x D x Usable Height in mm x mm x mm)	H 16	500 mm x 440 mm x 275 mm / 400 mm x 245 mm x 165 mm
	H 24	700 mm x 440 mm x 275 mm / 600 mm x 245 mm x 165 mm
	H 41	510 mm x 490 mm x 476 mm / 410 mm x 296 mm x 335 mm
	H 22	500 mm x 440 mm x 345 mm / 400 mm x 245 mm x 225 mm
	H 8 A	340 mm x 395 mm x 345 mm / 245 mm x 200 mm x 165 mm
	H 16 A	500 mm x 440 mm x 345 mm / 400 mm x 245 mm x 165 mm
Model / Usable Height (plus approx. 30 mm beneath the Water Bath's lid)	H 4	165 mm / 114 mm / 41 / 3,5 l
/ max water level above perforated floor up to marking "max"	H 8	165 mm / 114 mm / 81 / 6,9 l
/ Volume (in litres)	H 16	165 mm / 114 mm / 16 l / 13,7 l
/ Filling quantity from bottom of Water Bath up to marking "max" (in litres)	H 24	165 mm / 114 mm / 24 l / 20,6 l
	H 41	335 mm / 284 mm / 41 l / 37,6 l
	H 22	225 mm / 174 mm / 22 l / 19,6 l
	H 8 A	165 mm / 114 mm / 81 / 6,9 l
	H 16 A	165 mm / 114 mm / 16 l / 13,7 l
Temperature range		
Display can be switched between °C and °F		
Models H 4, H 8, H 16, H 24, H 41 und H 22		approx. 5 K above ambient to 100 °C
Models H 8 A und H 16 A		approx. 10 K above ambient to 100 °C
Temperature regulation		Electronic, PI-type
Temperature constancy at 50 °C		+/- 0.1 K (temporal)
Temperature setting and display		Through four membrane keys and a 3.5" TFT colour display, 0.1 K increments
Temperature cut-offs		
Over-temperature cut-out, dependent on set point		Adjustable between 0 K and +10 K, factory setting 4 K above set point
Under-temperature cut-out, dependent on set point		Adjustable between 0 K and -10 K, factory setting -9 K below set point
Low water cut-off		Electro-mechanical temperature limiter with capillary tube sensor. Cut-off temperature 135 °C - 10 K
Electrical connection		230 V +/- 10 %, 50 / 60 Hz
Model / power	H 4 / 0,5 kW	H 41 / 1,5 kW
	H 8 / 1,0 kW	H 22 / 1,5 kW
	H 16 / 1,5 kW	H 8 A / 1,0 kW
	H 24 / 1,5 kW	H 16 A / 1,5 kW
Mains connection		Shock-proof plug, CEE 7/7
Mains fuse, internally		8 A, 6.3 x 32 mm fine fuse, delay-action
Mains fuse, on-site		10 A - max.16 A
Protection type / protection class		IP20 / I
Ambient conditions		
Laboratory rooms		Use only indoors (Not in potentially explosive surroundings)
Height above sea level		Up to 2000 m
Ambient temperature r		+10 °C to +40 °C
Humidity		Max 80 % rel. humidity to 31 °C, decreasing to 50 % rel. humidity at 40 °C.
Emission sound pressure level		Models H 8 A / H 16 A > 70 dB(A)
Model / weight	H 4 / 7,4 kg	H 41 / 21,2 kg
	H 8 / 9,3 kg	H 22 / 14,9 kg
	H 16 / 13,3 kg	H 8 A / 10,9 kg
	H 24 / 17,2 kg	H 16 A / 15,2 kg

13 Circuit diagram

- A1 Electronic temperature regulator
- B1 Temperature sensor
- E1 Heating element
- F1 Fuse 8 A T
- F2 Fuse 8 A T
- F3 Low water cut-off
- M1 Stirrer motor (Models H 8 A / H 16 A)
- R1 Multiplier M1 (Models H 8 A / H 16 A)
- S1 Main switch
- TA1 Key ①, see chapter 8
- TA2 Key ②, see chapter 8
- TA3 Key ③, see chapter 8
- TA4 Key ④, see chapter 8
- V1 Triac

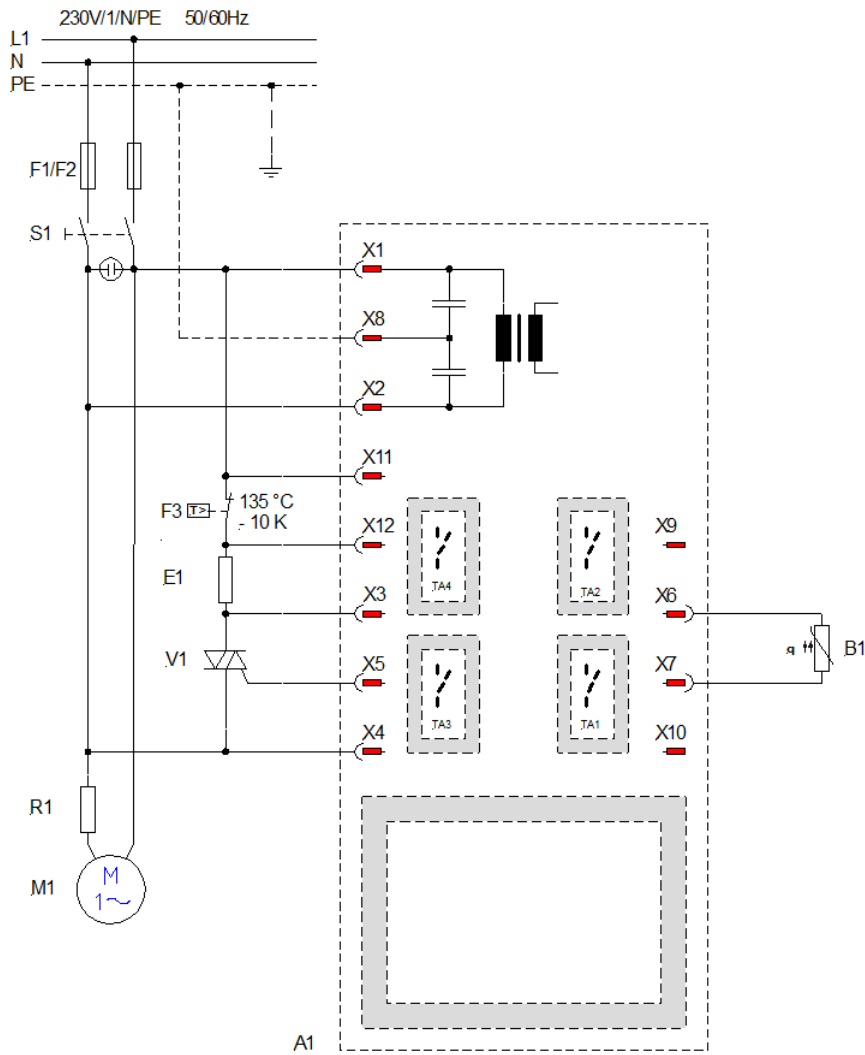

14 Examples for connection to the mains supply

The standard version of the water bath models H 4 to H 16 A is supplied with a pre-installed mains plug. Make sure to connect to a protective conductor terminal.

Colour coding of mains cable
 ge/gr – yellow/green
 bl – blue
 sw – black

Mains supply
 PE (Protective earth)
 N
 L1

All Water Baths supplied for 230 V (see information on the nameplate) can be connected to all power supplies of 220 V or 230 V. Maximum grid impedance $Z_{max} = 0,135 \Omega$. If necessary, this value should be requested from the responsible energy supply company.

14.1 Electrical fuses

Model	Power	Power consumption at mains voltage *	Mains fuse (F4, F5)
H 4	0,5 kW	2,2 Amp at 230 V	10 A / Amp (max. 16 A / Amp.)
H 8, H 8 A	1,0 kW	4,4 Amp at 230 V	10 A / Amp (max. 16 A / Amp.)
H 16, H 22, H 24, H 41, H 16 A	1,5 kW	6,5 Amp at 230 V	10 A / Amp (max. 16 A / Amp.)

* see nameplate

14.2 Examples for connection to the mains

Components

- B1 Earthing contact socket (on-site)
- B2 Earthing contact plug (mounted on the unit)
- F4 Mains fuse (on-site)
- F5 Mains fuse (on-site)

Models H 4, H 8, H 16, H 22, H 24, H 41,
H 8 A, H 16 A for 230 V with power
supply 230 V / N / PE / 50/60 Hz,
connected through 3-pole shock-proof
(Schuko) plug system.

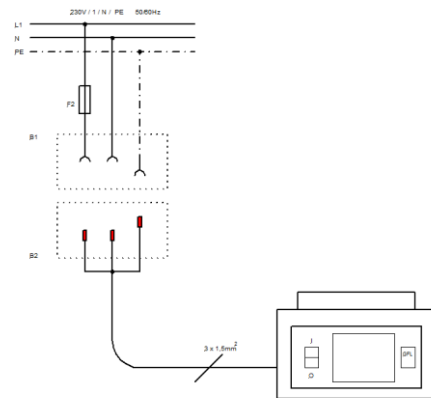

Models H 4, H 8, H 16, H 22, H 24, H 41,
H 8 A, H 16 A for 230 V with power
supply 400 V / 3 / N / PE / 50/60 Hz,
connected through 3-pole shock-proof
(Schuko) plug system.

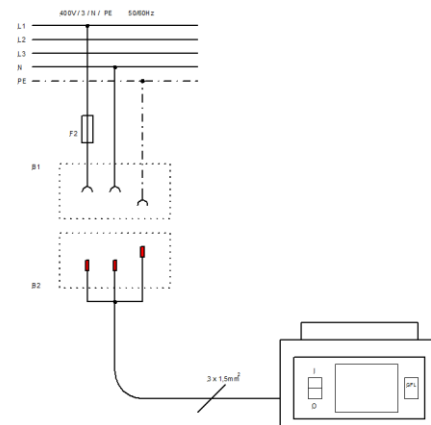

Models H 4, H 8, H 16, H 22, H 24, H 41,
H 8 A, H 16 A for 230 V with power
supply 220 V / 3 / N / PE / 50/60 Hz,
connected through 3-pole shock-proof
(Schuko) plug system.

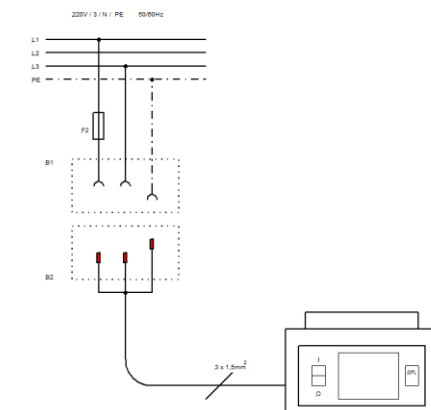

15 Accessories



Adjustable Water Level Regulator for keeping water level constant and for cooling the Water Bath (also refer to chapter 7 Special Accessory Level Regulator).

Order-No. A000024

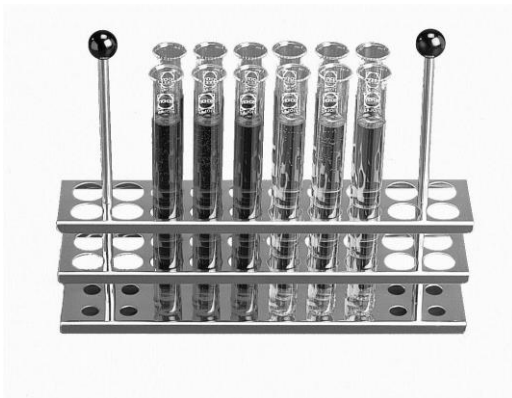

Stainless Steel Rack for test tubes and bottles

Order-No. A000015	with 20 openings	Ø 18 mm
Order-No. A000016	with 5 openings	Ø 31 mm
Order-No. A000017	with 20 openings	Ø 13 mm
Order-No. A000022	with 12 openings	Ø 56 mm

17 Ordering spare parts / LAUDA Service

When ordering spare parts, please state the serial number (type plate) to avoid queries and wrong deliveries.

Your partner for maintenance and competent service support:

LAUDA Service
Telefon: +49 (0)9343 503-350
Fax: +49 (0)9343 503-283
E-Mail service@lauda.de

We are always at your disposal for questions and suggestions!

LAUDA DR. R. WOBSE GMBH & CO. KG
Laudaplatz 1
97922 Lauda-Königshofen
Germany
Telefon: +49 (0)9343 503-0
Fax: +49 (0)9343 503-222
E-Mail info@lauda.de
Internet : <http://www.lauda.de/>

18 Product Returns and Clearance Declaration



Product Returns and Clearance Declaration

Product Returns

Would you like to return a LAUDA product you have purchased to LAUDA? For the return of goods, e.g. for repair or due to a complaint, you will need the approval of LAUDA in the form of a *Return Material Authorization (RMA)* or *processing number*. You can obtain the RMA number from our customer service department at +49 (0) 9343 503 350 or by email service@lauda.de.

Return address

LAUDA DR. R. WOBSE GMBH & CO. KG

Laudaplatz 1

97922 Lauda-Königshofen

Deutschland/Germany

Clearly label your shipment with the RMA number. Please also enclose this fully completed declaration.

RMA number	Product serial number
Customer/operator	Contact name
Contact email	Contact telephone
Zip code	Place
Street & house number	
Additional explanations	

Clearance Declaration

The customer/operator hereby confirms that the product returned under the above-mentioned RMA number has been carefully emptied and cleaned, that any connections have been sealed to the farthest possible extent, and that there are no explosive, flammable, environmentally hazardous, biohazardous, toxic, radioactive or other hazardous substances in or on the product.

Place, date	Name in block letters	Signature

Version 02 - EN



EC DECLARATION OF CONFORMITY

Manufacturer: LAUDA DR. R. WOBSER GMBH & CO. KG
Schulze-Delitzsch-Straße 4+5, 30938 Burgwedel, Germany

We hereby declare under our sole responsibility that the machines described below

Product Line: Hydro **Serial number:** from 220_____

Types: H 4, H 8, H 8 A, H 16, H 16 A, H 22, H 24 and H 41
H 20 S, H 20 SW and H 20 SOW
H 5 V, H 6 V, H 9 V, H 11 V and H 19 V
H 2 P

comply with all relevant provisions of the EC Directives listed below due to their design and type of construction in the version brought on the market by us:

Machinery Directive	2006/42/EC
EMC Directive	2014/30/EU
RoHS Directive	2011/65/EU in connection with (EU) 2015/863

The protective objectives of the Machinery Directive with regard to electrical safety are complied with in accordance with Annex I Paragraph 1.5.1 in conformity with the Low Voltage Directive 2014/35/EU.

Applied standards:

- EN 61326-1:2013
- EN 61010-1:2010/A1:2019/AC:2019-04
- EN IEC 61010-2-010:2020

Authorized representative for the composition of the technical documentation:

Dr. Jürgen Dirscherl, Head of Research & Development

Burgwedel, 05.06.2023



Dr. Alexander Dinger,
Head of Quality and Environmental Management

*FAHRENHEIT. *CELSIUS. *LAUDA.

Q5WA-QA13-028-EN-01

LAUDA DR. R. WOBSE GMBH & CO. KG

Schulze-Delitzsch-Straße 4+5 ° 30938 Burgwedel ° Germany

Tel.: +49 (0) 5139 9958-0 ° Fax +49 (0) 5139 9958-21

E-Mail: info@lauda.de ° Internet: <https://www.lauda.de>